

# AHS36A-BAK016384

AHS/AHM36

**ABSOLUTE ENCODERS**

**SICK**  
Sensor Intelligence.

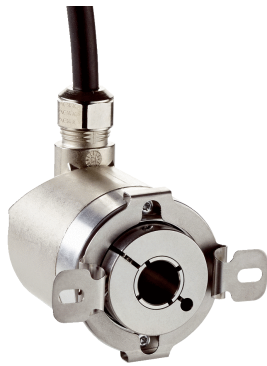

Illustration may differ



### Ordering information

Type	Part no.
AHS36A-BACK016384	1066003

Other models and accessories → [www.sick.com/AHS\\_AHM36](http://www.sick.com/AHS_AHM36)

### Detailed technical data

#### Performance

<b>Number of steps per revolution (max. resolution)</b>	16,384 (14 bit)
<b>Error limits G</b>	± 0.35° (at 20 °C) <sup>1)</sup>
<b>Repeatability standard deviation <math>\sigma_r</math></b>	± 0.2° (at 20 °C) <sup>2)</sup>

<sup>1)</sup> In accordance with DIN ISO 1319-1, position of the upper and lower error limit depends on the installation situation, specified value refers to a symmetrical position, i.e. deviation in upper and lower direction is the same.

<sup>2)</sup> In accordance with DIN ISO 55350-13; 68.3% of the measured values are inside the specified area.

#### Interfaces

<b>Communication interface</b>	CANopen
<b>Data protocol</b>	CANopen CiA DS-301 V4.02, CiA DSP-305 LSS, Encoder Profile: - CiA DS-406, V3.2. - Class C2
<b>Address setting</b>	0 ... 127, default: 5
<b>Data transmission rate (baud rate)</b>	20 kbit/s ... 1,000 kbit/s, default: 125 kbit/s
<b>Process data</b>	Position, speed, temperature
<b>Parameterising data</b>	Number of steps per revolution PRESET Counting direction Sampling rate for speed calculation Unit for output of the speed value Electronic cams(2 channels x 8 cams)
<b>Available diagnostics data</b>	Minimum and maximum temperature, maximum speed, power-on counter, operating hours counter power-on/motion, counter of direction changes/number of movements cw/number of movements ccw, minimum and maximum operating voltage
<b>Status information</b>	CANopen status via status LED
<b>Bus termination</b>	Via external terminator <sup>1)</sup>
<b>Initialization time</b>	2 s <sup>2)</sup>

<sup>1)</sup> See accessories.

<sup>2)</sup> Valid positional data can be read once this time has elapsed.

## Electrical data

<b>Connection type</b>	Cable, 5-wire, universal, 1.5 m
<b>Supply voltage</b>	10 ... 30 V
<b>Power consumption</b>	Cable, 5-wire ≤ 1.5 W (without load)
<b>Reverse polarity protection</b>	✓
<b>MTTFd: mean time to dangerous failure</b>	270 years (EN ISO 13849-1) <sup>1)</sup>

<sup>1)</sup> This product is a standard product and does not constitute a safety component as defined in the Machinery Directive. Calculation based on nominal load of components, average ambient temperature 40 °C, frequency of use 8760 h/a. All electronic failures are considered hazardous. For more information, see document no. 8015532.

## Mechanical data

<b>Mechanical design</b>	Blind hollow shaft
<b>Shaft diameter</b>	6 mm
<b>Weight</b>	0.12 kg <sup>1)</sup>
<b>Shaft material</b>	Stainless steel
<b>Flange material</b>	Aluminum
<b>Housing material</b>	Zinc
<b>Material, cable</b>	PUR
<b>Start up torque</b>	1 Ncm
<b>Operating torque</b>	< 1 Ncm
<b>Permissible movement static</b>	± 0.3 mm (radial) ± 0.3 mm (axial)
<b>Permissible movement dynamic</b>	± 0.1 mm (radial) ± 0.1 mm (axial)
<b>Moment of inertia of the rotor</b>	15 gcm <sup>2</sup>
<b>Bearing lifetime</b>	2.0 x 10 <sup>9</sup> revolutions
<b>Angular acceleration</b>	≤ 500,000 rad/s <sup>2</sup>
<b>Operating speed</b>	≤ 6,000 min <sup>-1</sup> <sup>2)</sup>

<sup>1)</sup> Relates to devices with male connector connection.

<sup>2)</sup> Self warming of 3.5 K per 1000 revolutions/min when applying note working temperature range.

## Ambient data

<b>EMC</b>	According to EN 61000-6-2 and EN 61000-6-3
<b>Enclosure rating</b>	IP66 (according to IEC 60529) IP67 (according to IEC 60529)
<b>Permissible relative humidity</b>	90 % (Condensation not permitted)
<b>Operating temperature range</b>	-40 °C ... +85 °C
<b>Storage temperature range</b>	-40 °C ... +100 °C, without package
<b>Resistance to shocks</b>	100 g, 6 ms (according to EN 60068-2-27)
<b>Resistance to vibration</b>	20 g, 10 Hz ... 2,000 Hz (according to EN 60068-2-6)

## Classifications

<b>ECl@ss 5.0</b>	27270502
<b>ECl@ss 5.1.4</b>	27270502
<b>ECl@ss 6.0</b>	27270590

<b>ECl@ss 6.2</b>	27270590
<b>ECl@ss 7.0</b>	27270502
<b>ECl@ss 8.0</b>	27270502
<b>ECl@ss 8.1</b>	27270502
<b>ECl@ss 9.0</b>	27270502
<b>ECl@ss 10.0</b>	27270502
<b>ECl@ss 11.0</b>	27270502
<b>ETIM 5.0</b>	EC001486
<b>ETIM 6.0</b>	EC001486
<b>ETIM 7.0</b>	EC001486
<b>UNSPSC 16.0901</b>	41112113

### Dimensional drawing (Dimensions in mm (inch))

Blind hollow shaft, cable outlet

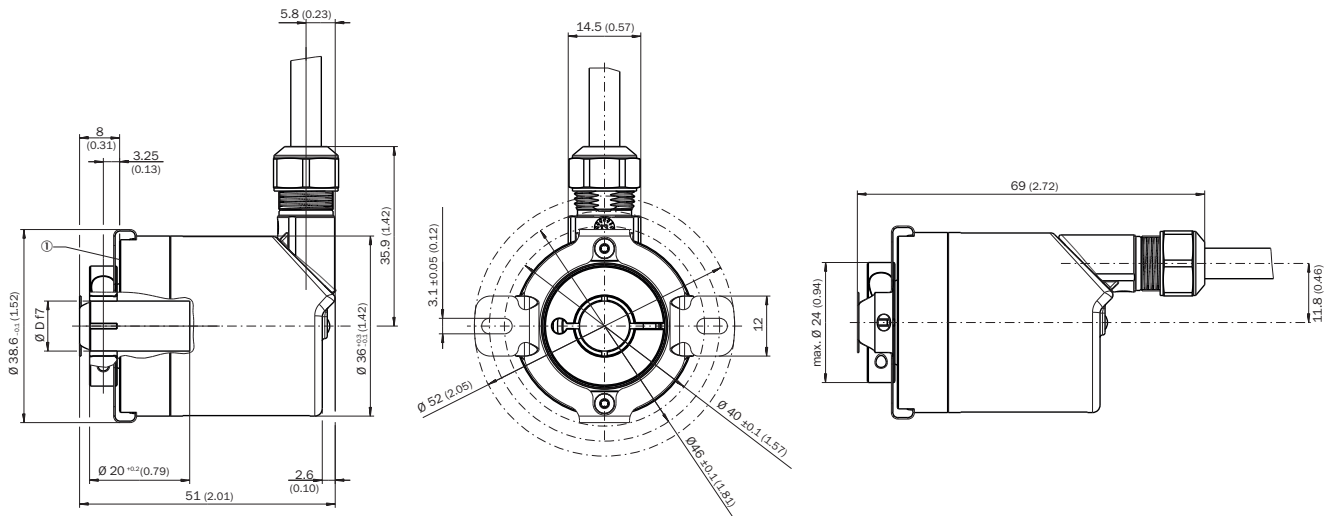

① Measuring point for operating temperature

### PIN assignment

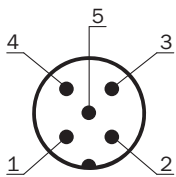













PIN	Signal	Wire colors (cable connection)	Function
1	CAN Shield	White	Screen
2	VDC	Red	Supply voltage Encoder 10 V DC ... 30 V DC
3	GND/CAN GND	Blue	0 V (GND)

PIN	Signal	Wire colors (cable connection)	Function
4	CAN high	Black	CAN signal
5	CAN low	Pink	CAN signal
Housing	-	-	Screen

### Recommended accessories

Other models and accessories → [www.sick.com/AHS\\_AHM36](http://www.sick.com/AHS_AHM36)

	Brief description	Type	Part no.
<b>Flanges</b>			
	Stator coupling on hole circle 63 mm	BEF-DS08	2072206
	Standard stator coupling, AHS/AHM36	BEF-DS16-AHX	2108615
<b>Adapters and distributors</b>			
	T-piece for simultaneous connection to sender and receiver, splits the cable from the control cabinet to the sender and receiver, 5-pin	DSC-1205T000025KM0	6030664
	Y-CAN cable	Y-CAN cable	6027647
<b>Plug connectors and cables</b>			
	Head A: Flying leads Head B: Flying leads Cable: CANopen, DeviceNet™, shielded Wire shield Al-Pt film, overall shield C-screen tin-plated	LTG-2804-MW	6028328
	Head A: female connector, M12, 5-pin, straight Head B: Flying leads Cable: CANopen, DeviceNet™, shielded, 2 m A-coded	DOL-1205-G02MY	6053041
	Head A: female connector, M12, 5-pin, straight Head B: Flying leads Cable: CANopen, DeviceNet™, shielded, 5 m A-coded	DOL-1205-G05MY	6053042
	Head A: female connector, M12, 5-pin, straight Head B: Flying leads Cable: CANopen, DeviceNet™, shielded, 10 m A-coded	DOL-1205-G10MY	6053043
	Head A: female connector, M12, 5-pin, straight Head B: male connector, M12, 5-pin, straight Cable: CANopen, DeviceNet™, PUR, halogen-free, shielded, 2 m A-coded	DSL-1205-G02MY	6053044
	Head A: female connector, M12, 5-pin, straight Head B: male connector, M12, 5-pin, straight Cable: CANopen, DeviceNet™, PUR, halogen-free, shielded, 5 m A-coded	DSL-1205-G05MY	6053045

	Brief description	Type	Part no.
	Head A: female connector, M12, 5-pin, straight Head B: male connector, M12, 5-pin, straight Cable: CANopen, DeviceNet™, PUR, halogen-free, shielded, 10 m A-coded	DSL-1205-G10MY	6053046
	Head A: female connector, M12, 5-pin, straight Cable: CANopen, DeviceNet™, shielded	DOS-1205-GA	6027534
	Head A: male connector, M12, 5-pin, straight, A-coded Cable: CANopen, DeviceNet™, shielded	STE-1205-GA	6027533
	Head A: male connector, M12, 5-pin, straight Cable: CANopen, unshielded	STE-1205-GKEND	6037193
	Head A: male connector, M12, 5-pin, straight Cable: CANopen, unshielded	CAN male connector	6021167
<b>Programming and configuration tools</b>			
	Hand-held programming device for the programmable SICK AHS/AHM36 CANopen encoders, TMS/TMM61 CANopen inclination sensors, TMS/TMM88 CANopen, TMS/TMM88 Analog, and wire draw encoders with AHS/AHM36 CANopen. Compact dimensions, low weight, and intuitive operation.	PGT-12-Pro	1076313

## SICK AT A GLANCE

SICK is one of the leading manufacturers of intelligent sensors and sensor solutions for industrial applications. A unique range of products and services creates the perfect basis for controlling processes securely and efficiently, protecting individuals from accidents and preventing damage to the environment.

We have extensive experience in a wide range of industries and understand their processes and requirements. With intelligent sensors, we can deliver exactly what our customers need. In application centers in Europe, Asia and North America, system solutions are tested and optimized in accordance with customer specifications. All this makes us a reliable supplier and development partner.

Comprehensive services complete our offering: SICK LifeTime Services provide support throughout the machine life cycle and ensure safety and productivity.

For us, that is “Sensor Intelligence.”

## WORLDWIDE PRESENCE:

Contacts and other locations –[www.sick.com](http://www.sick.com)